

# 鉄筋コンクリート組立塀(万年塀)

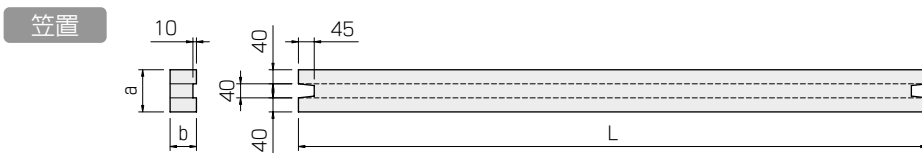
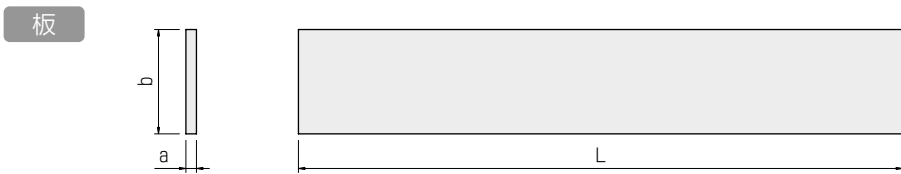
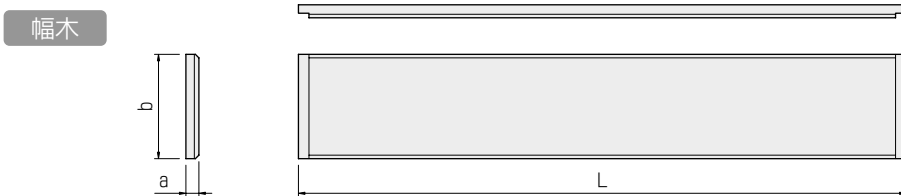
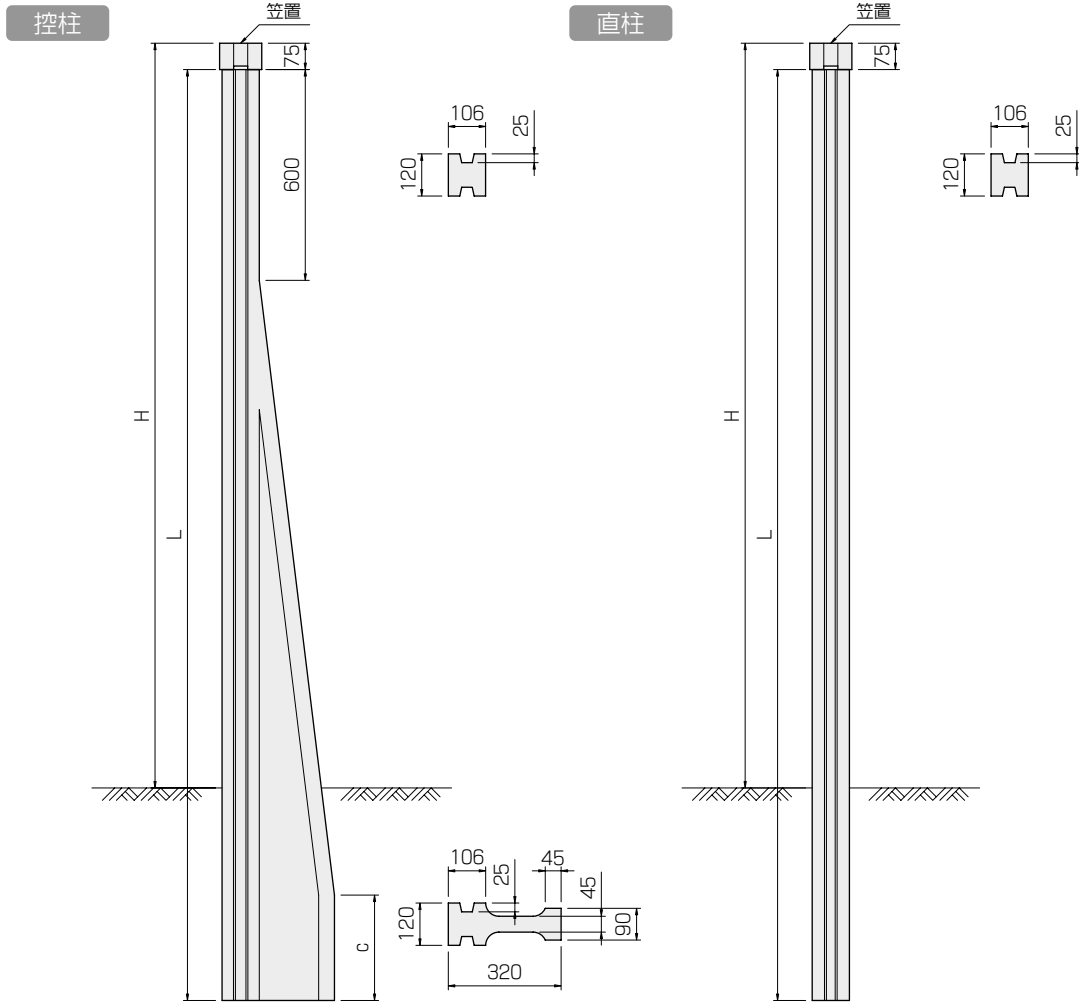

種類	寸法(mm)						参考重量(kg)
	H	L	a	b	c		
控柱	6番	1820	2350	—	—	—	92
	7番	2120	2650	—	—	300	115
直柱	6番	1820	2350	—	—	—	56
	7番	2120	2650	—	—	—	65
板	幅木	—	1730	37	297	—	42
	板	—	1720	30	297	—	34
笠置	—	1790	120	75	—	35	

※隅柱、角柱もございます。

控柱用

参考重量 436kg

直柱用

参考重量 478kg

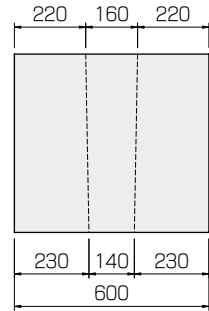
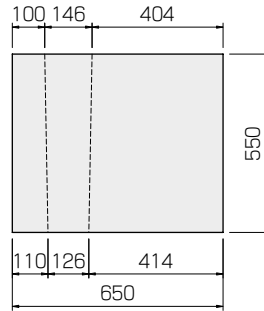
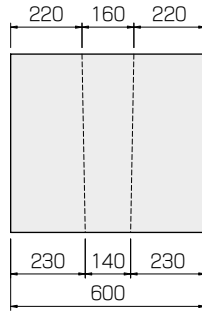
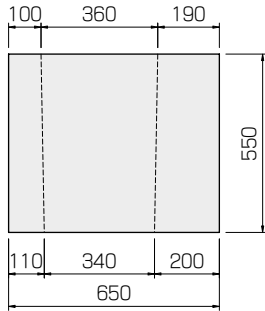
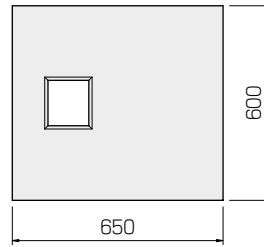
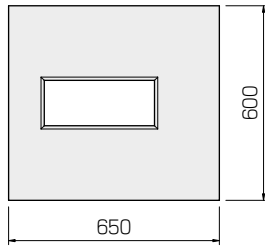

組立図

